



TechBook

in.k1000+

full-featured color capacitive
touchscreen display keypad for spas



A touch of engineering magic!

Now with your own personal swim coach!

Now connects to the Internet of Things!





Table of contents

Warning	2
Introduction	3
Overview	
- in.k1000+ dimensions	4
- in.k1001+ dimensions	5
Installation	
- Installation of in.k1000+	6
- Drilling template	7
- Installation notes	9
- Connecting in.k1000+ to the spa pack	9
Keypad functions	
- in.k1000+ keypad layout	11
- Sleep mode	11
- Main screen	11
- Start or stop accessories	12
- Notifications	12
- Water temperature	13
- Spa menu	13
- Display page	13
- Contrast page	14
- Sleep	14
- Settings	14
- Water Care	15
- Modifying schedules	16
- Heat Pump	17
- Maintenance	19
- Reminders	19
- Standby	19
- Date and Time	19
- Keypad settings	20
- Temperature units	21
- Display page	21
- Contrast page	21
- Language select	22
- Keypad lock/unlock (optional)	22
- Keypad Color (optional)	23
- Electrical Configuration	23
- Select logo	24
- Wi-Fi (in.touch only)	24
- Wi-Fi (in.touch 2)	25
- Miscellaneous	25
- Warm weather	25
- Info messages	26
- About	26
- Wipe screen	26
- Swim functions	27
- in.stream 2 functions	32
- in.clear functions	34
- in.mix functions	36
Error messages	37
Feature matrix	38
Specifications	39



Warning



WARNING:

Before installing or connecting the unit, please read the following.

FAILURE TO COMPLY WITH THE FOLLOWING WARNINGS MAY SIGNIFICANTLY SHORTEN THE PRODUCT'S LIFE TIME, AND LEAD TO FAILURES AS WELL AS HAZARDOUS CONDITIONS*. COMMON SENSE MUST ALWAYS PREVAIL WHEN EVALUATING THE INSTALLATION AND/OR USE OF ANY ELECTRONIC CONTROL IN A FINAL APPLICATION.

- * RESPECT ENVIRONMENTAL CONDITIONS LISTED AT END OF TECHBOOK.
- * THIS UNIT MUST BE INSTALLED BY QUALIFIED PERSONNEL.
- * ONLY QUALIFIED PERSONNEL ARE TO SERVICE THIS UNIT. THERE ARE NO USER SERVICEABLE PARTS INSIDE.
- * THIS UNIT SHOULD BE INSTALLED ON A CLEAN FLAT SURFACE.
- * THE GASKET ON THE BACK OF THE UNIT WILL PREVENT WATER INFILTRATION INSIDE, BEHIND THE MOUNTED SURFACE. IF THE GASKET IS DAMAGED, SEAL THE BACK OF THE UNIT WITH SILICONE TO AVOID ANY LEAKAGE BEHIND THE MOUNTED SURFACE.
- * THIS UNIT MUST BE MOUNTED ON THE OUTSIDE EDGE OF THE SPA. SEE INSTALLATION SECTION FOR DETAILS.
- * THE BACK OF THIS UNIT SHOULD NOT BE ENCLOSED IN A WAY THAT CAUSES WATER TO COLLECT. SEE INSTALLATION SECTION FOR DETAILS.
- * HAZARDOUS CONDITION:
A CONDITION THAT IS POTENTIALLY DAMAGING AND/OR DANGEROUS TO THE OPERATOR OR SURROUNDINGS. THIS INCLUDES, BUT IS NOT LIMITED TO: FIRE, FLOODING OR OTHER WATER DAMAGE, DIELECTRIC BREAKDOWNS (PRESENCE OF HIGH VOLTAGE), ETC.

MAINTENANCE

IF YOU HAVE PROBLEMS, DO NOT ATTEMPT TO REPAIR THE UNIT YOURSELF. RETURN IT TO YOUR DEALER OR SERVICE STATION FOR SERVICING.

ACCESSORY PARTS

BE SURE TO USE ONLY THE SPECIFIED ACCESSORY PARTS. USE OF OTHER THAN DESIGNATED PARTS MAY DAMAGE THIS UNIT INTERNALLY OR MAY NOT SECURELY INSTALL THE UNIT IN PLACE. THIS MAY CAUSE PARTS TO BECOME LOOSE RESULTING IN HAZARDS OR PRODUCT FAILURE.

DISPOSAL OF THE PRODUCT

THE APPLIANCE (OR THE PRODUCT) MUST BE DISPOSED OF SEPARATELY IN ACCORDANCE WITH THE LOCAL WASTE DISPOSAL LEGISLATION IN FORCE



Compatible spa controllers:

in.xm2, in.xe, in.yt, in.yj and in.ye with compatible software revision.

Aeware®, Gecko®, and their respective logos are Registered Trademarks of Gecko Alliance Group. in.k1000+™, in.xm2™, in.xe™, in.yt™, in.ye™, in.yj™, in.tune™, in.stream™, in.stream 2, in.mix™, in.clear™, in.touch™ and in.therm™, and their respective logos are trademarks of Gecko Alliance Group.

All other product or company names that may be mentioned in this publication are tradenames, trademarks or registered trademarks of their respective owners.



in.k1000+

full-featured color capacitive
touchscreen display keypad for spas

A touch of engineering magic!

Gecko's new version of its in.k1000 capacitive touch screen display keypad boasts a new state of the art touch screen with more precise fingertip contact areas for accurate target selection, enabling easier and more precise interactions.

in.k1000+ features optimal water resistance and lots of memory.

Now with your own personal swim coach!

With its swim spa training program, in.k1000+ can transform any swim spa into the ultimate training machine. Directly on the keypad, training sessions can be customized by setting flow intensities, durations and color indicators. Pre-sets Lap, Transition, Cardio and Power drills can also be selected and customized to match any training needs.

in.k1000+ can now control multiple 2 speed pumps and synchronize the jets to create the wide selection of water stream strengths a swimmer needs for serious training.

Now connects to the Internet of Things!

in.k1000+ can access the internet through its in.touch 2 connection, making your spa an integral part of the Internet of Things.



Overview

in.k1000+ dimensions

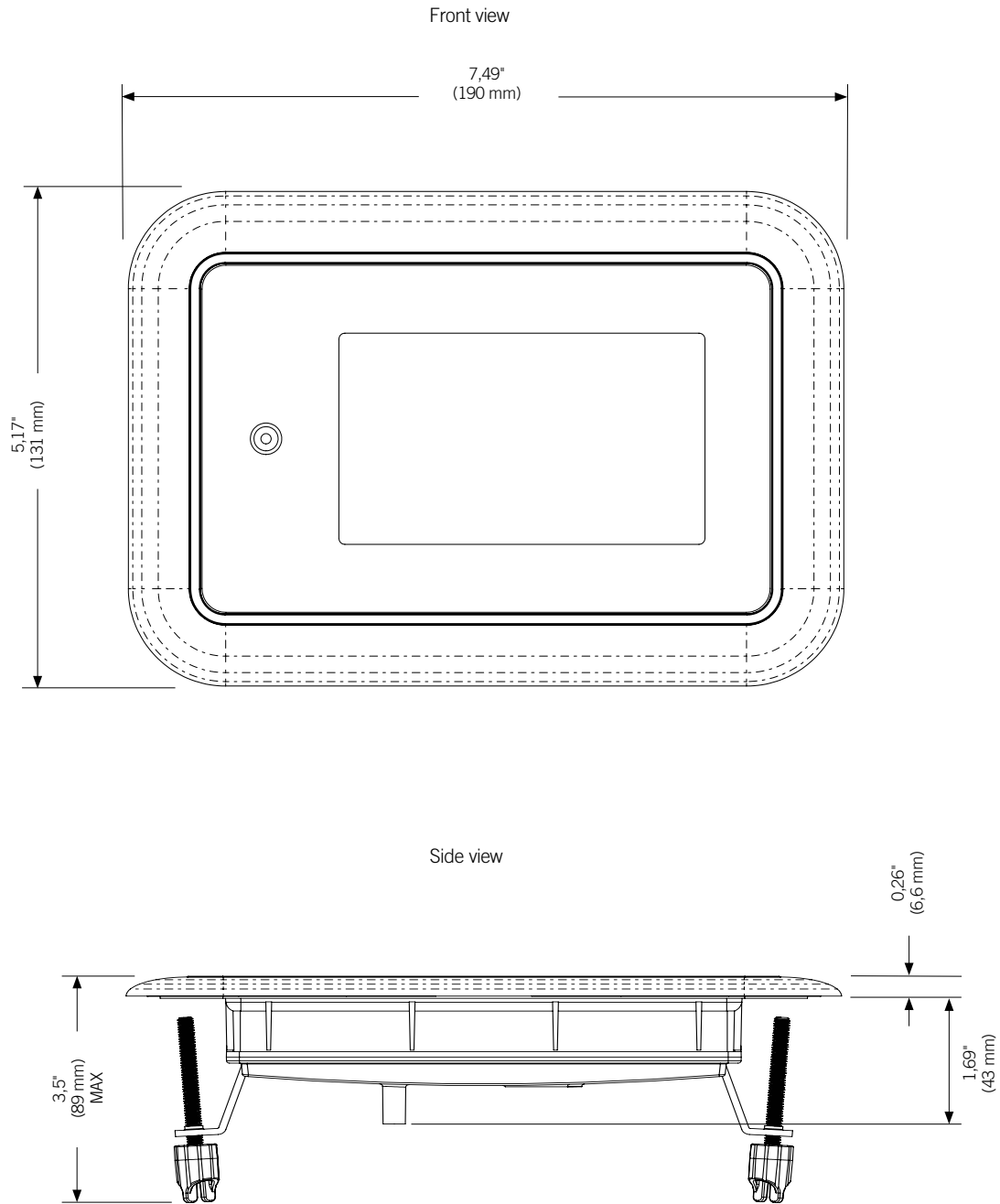

Overview

in.k1001+ dimensions

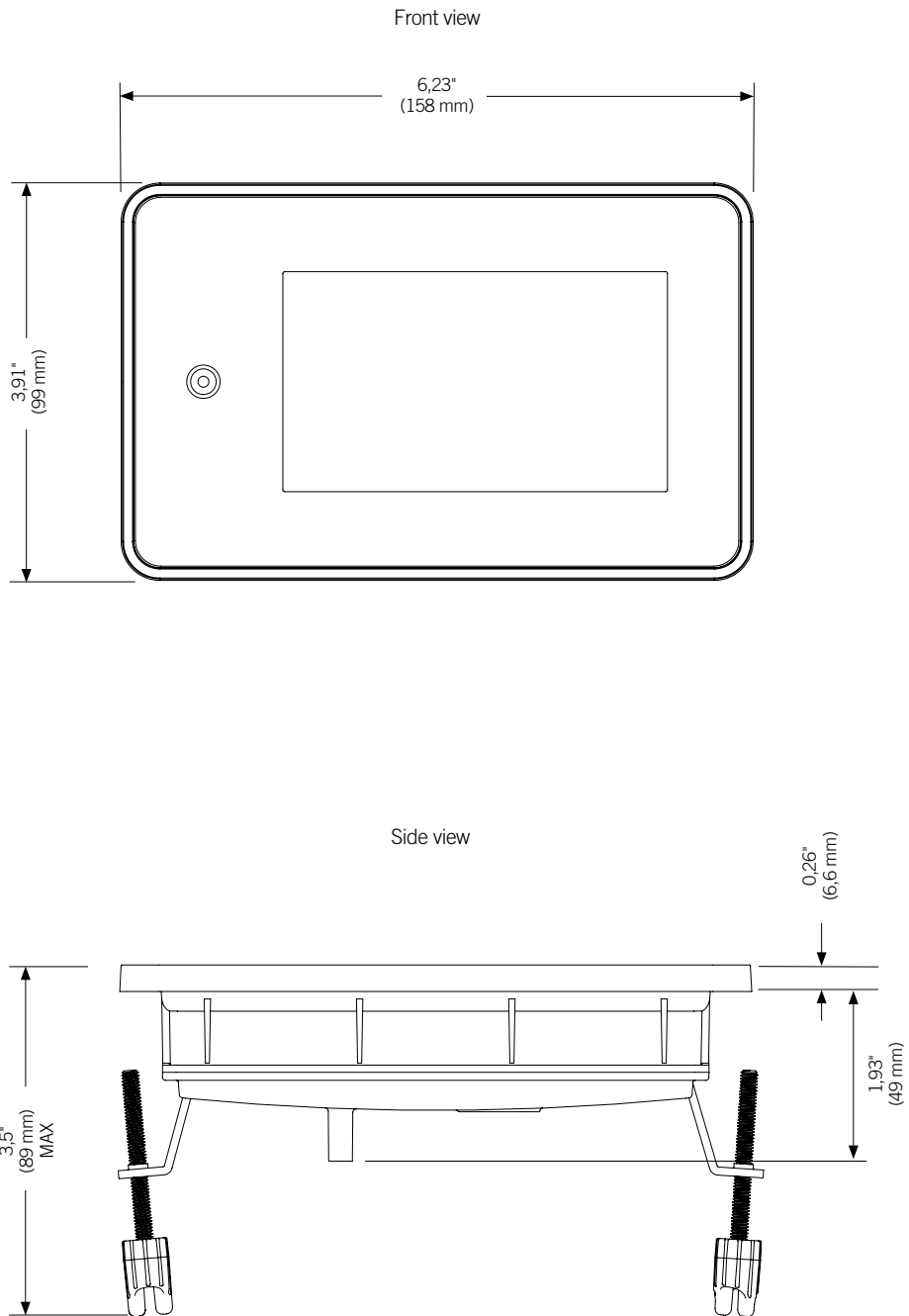



Installation

Installation of in.k1000+

To install the in.k1000+, use the drilling template provided in this section.

Determine the mounting location and stick the template on the chosen location.

Cut out an opening according to the template (see illustration).

Clean the installation surface and peel the adhesive gasket from the back of the keypad.

Insert the keypad and align it correctly, then ensure it is properly glued by gently pressing evenly on the entire surface.

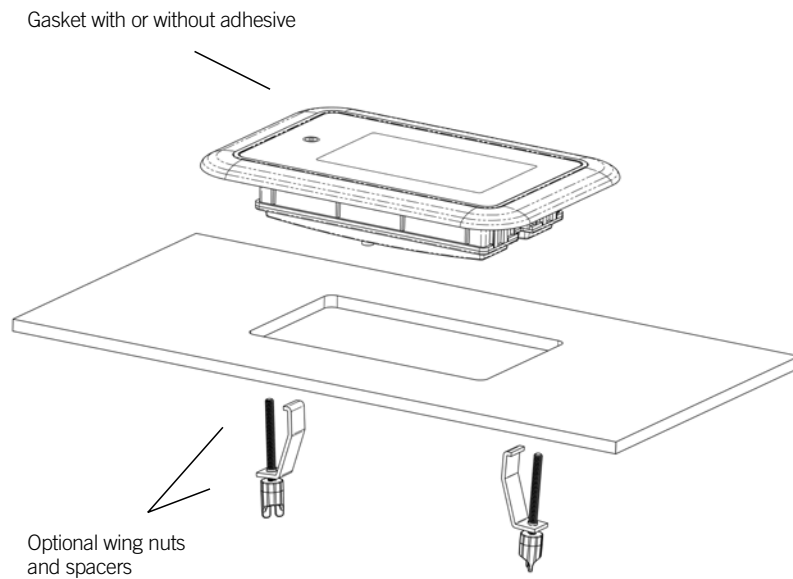



Installation

Drilling template

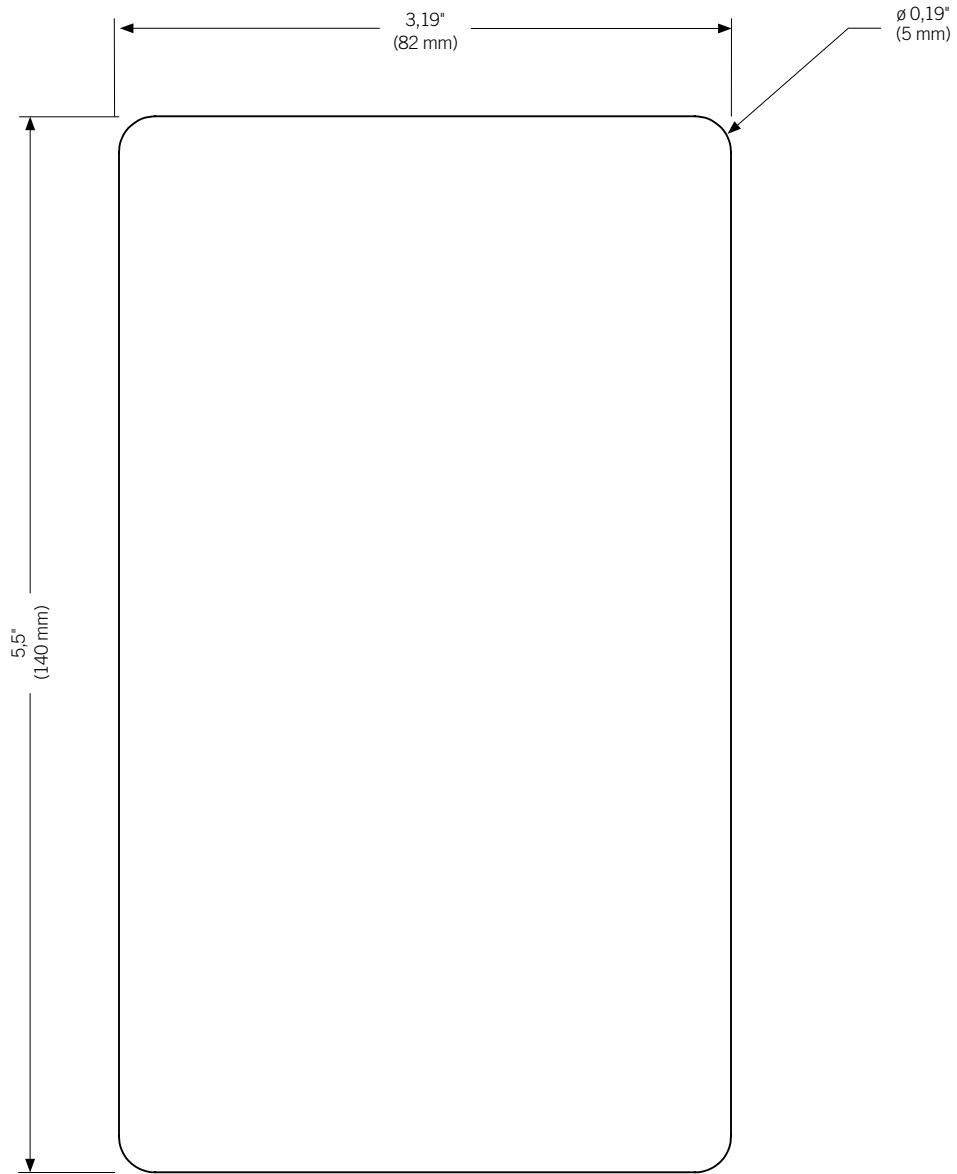



Installation

Drilling template

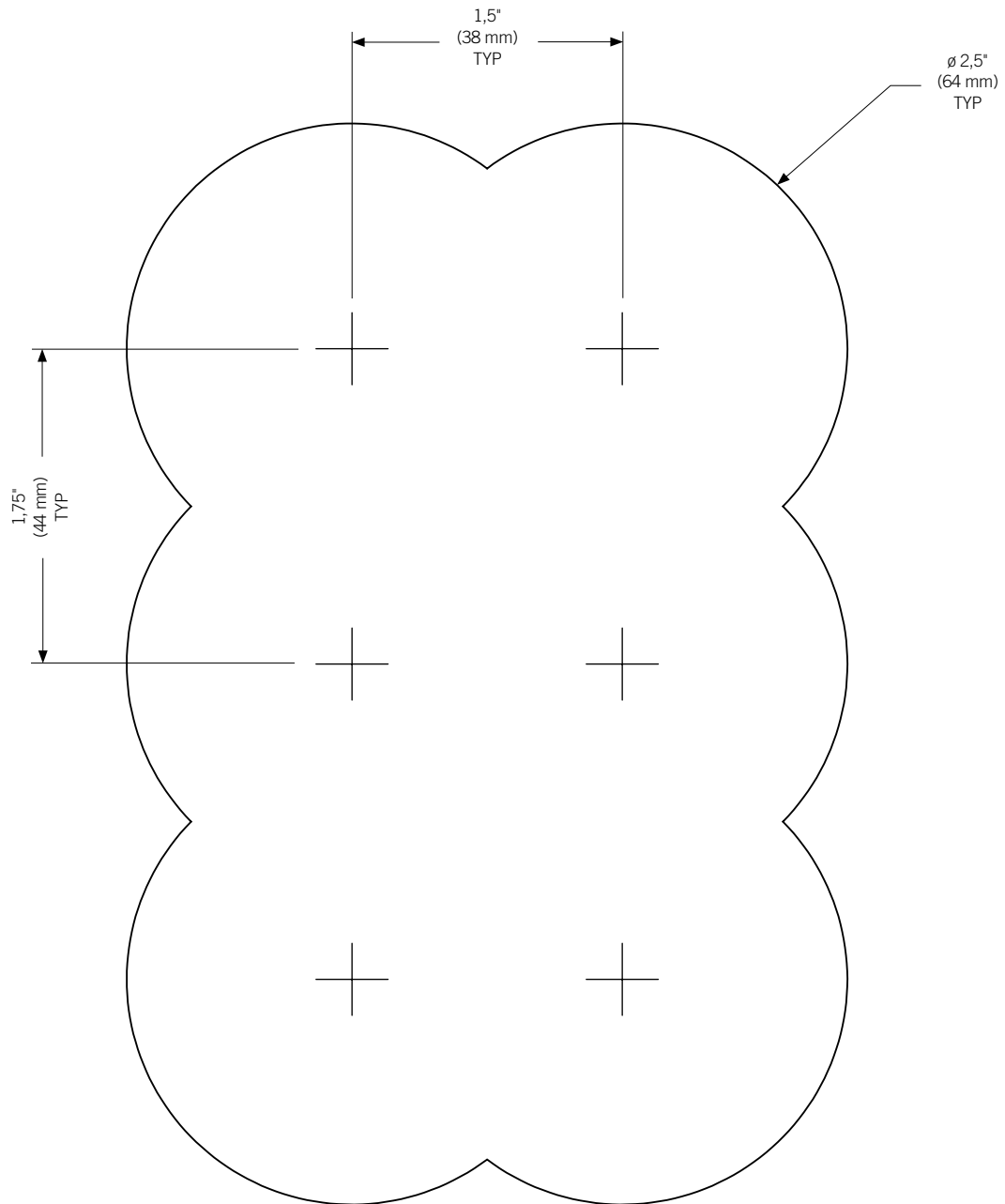

Installation

Installation notes

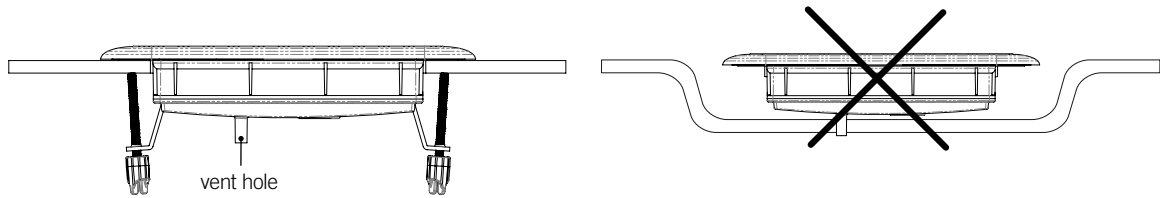

The vent hole on back of keypad should not be blocked.

The back of the in.k1000+ should not be enclosed where water can gather, but instead in a cut out.

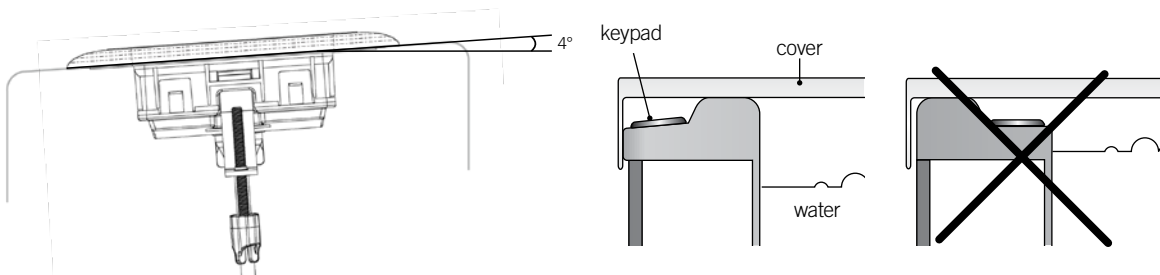

When installing the keypad on the spa, a minimum angle of 4 degrees must be respected.

Install the keypad facing the outside of the spa. Also make sure that the spa cover can never get in contact with the keypad glass surface.

Connecting in.k1000+ to the spa pack

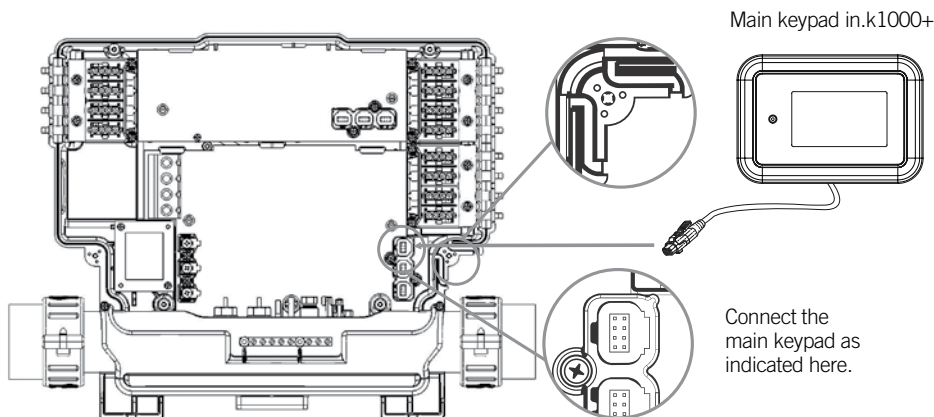

Note: always shut power down before connecting an accessory to the spa pack.

To connect the keypad, remove the cover, then insert the in.link connector into the appropriate keypad connector (as illustrated). Route the cable through one of the molded strain relief channels on the bottom right side of the spa pack (as illustrated). Fill the remaining space with the foam gaskets supplied. Don't forget to replace the cover and all screws (torque to 8 in. lb max (0.9 N.m)).



Installation

Upload

The spa pack does not have valid software. Please insert valid in.stick to reprogram spa pack.

WARNING

There's a problem communicating with the pack. Please check keypad connections or update pack software.

Installation errors

Upon connecting the in.k1000+ to the spa pack you may see one of two error messages.

Please follow the instructions in the message or contact your dealer for more information.

Keypad functions

in.k1000+ keypad layout



Sleep mode

Touch the screen to exit sleep mode. 3 minutes after the last pump is turned off, the screen will shut off if there is no touch activity.

Then Follow the instructions on the screen to access the main screen.

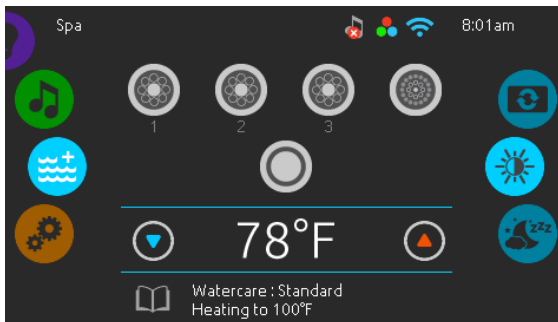

Main screen

The main screen gives you access to your accessories and water temperature. At the bottom of the screen you will see any error or maintenance messages that are present.



Keypad functions

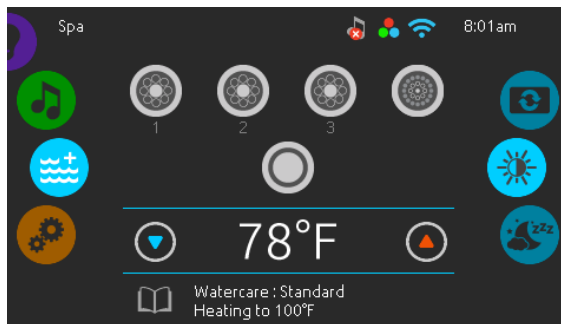
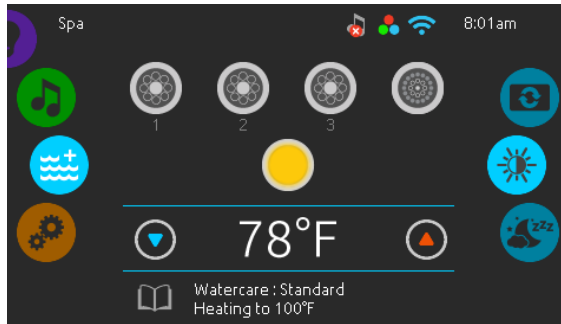

Start or stop accessories



To start or stop an accessory, touch the associated icon. Icons will become animated when their accessory is turned on and animation will stop when turned off. Icons on the screen will reflect the speed or state of the devices running on your spa. When an accessory has more than one speed press the button until it reaches the desired speed.

Notifications

A notification area at the top right-hand side of the screen shows the state of certain installed accessories.



Notification icons

in.touch:

-  Indicates that the in.touch module is detected and connected to a Wi-Fi network.
-  A red cross indicates that the in.touch module is detected but is not connected to a Wi-Fi network.
-  An animated icon indicates that the in.touch module is connecting to a Wi-Fi network.



For more information about the in.touch, refer to the Wi-Fi section.

in.clear:

-  The icon is green when the in.clear is generating bromine.
-  The icon is grey when the in.clear is not generating bromine.
-  A red cross indicates that the in.clear is turned off.

For more information about the in.clear, refer to the in.clear functions section.

in.stream 2:

-  The icon is green when the in.stream 2 is on.
-  A red cross indicates that the in.stream 2 is turned off.

For more information about the in.stream 2, refer to the in.stream 2 functions section.

in.mix:

-  Indicates that an in.mix system is detected.

For more information about the in.mix system, refer to the in.mix functions section.

Keypad functions

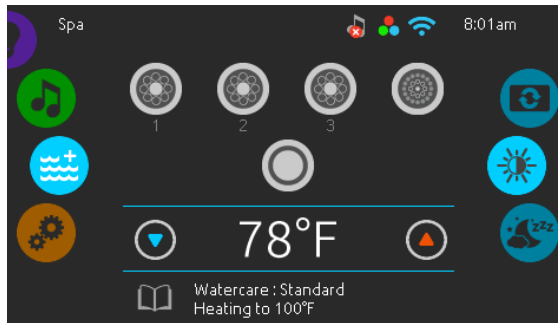

Water temperature

The temperature shown at the bottom of the screen indicates the current water temperature. Use the Up and Down icons to set the desired temperature. The set point will appear in blue. After 3 seconds without any change to the set temperature value the current water temperature will reappear in white.

When the set value is lower than the current temperature *Cooling to xx.x* will appear below. When the set value is higher than the current temperature, *Heating to xx.x* will be indicated under the value.

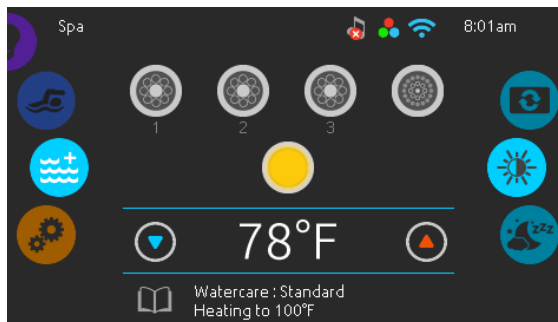

Spa menu

From the home page you can access the following:

- *swim (if configured)*
- *in.clear (if installed)*
- *in.stream 2 (if installed)*
- *in.mix (if installed)*
- *Spa menu*
- *Settings*

To select an option, slide the left wheel up or down until the desired icon menu is highlighted in the middle.

On the right side is a menu for access to the Display and Contrast pages.

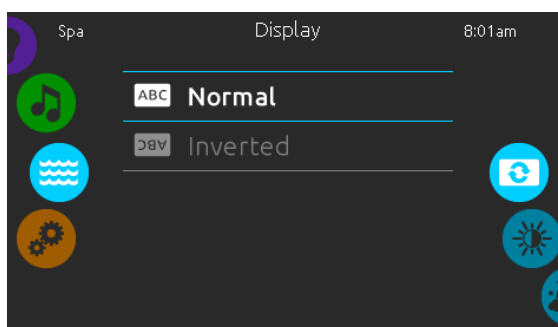

Display page

Use this page to change the display orientation.



Keypad functions

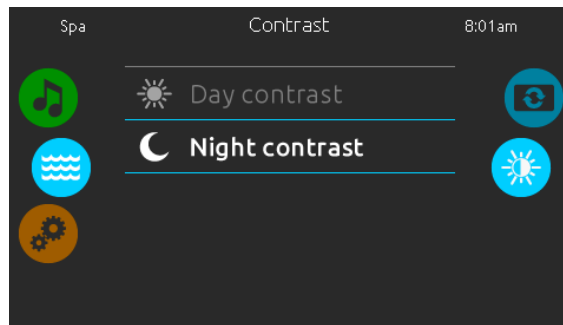

Contrast page

Use this page to change the display contrast.

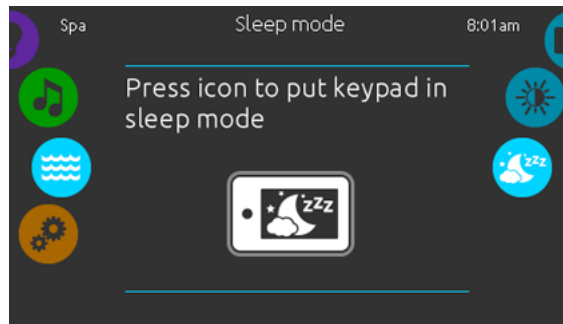

Sleep

Press key to go directly into the sleep mode. In sleep mode, water splashing on the keypad can't inadvertently start/stop a pump.

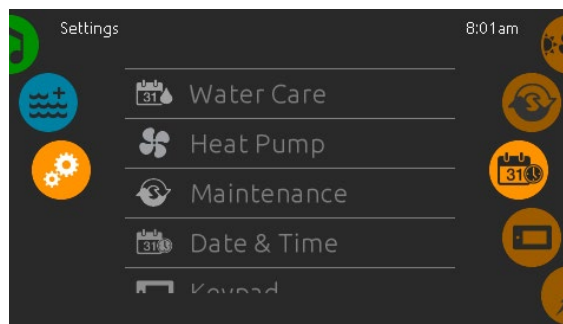

Settings

In the Settings page you can access the following:

- *Water Care*
- *Heat Pump (if installed)*
- *Maintenance*
- *Date & Time*
- *Keypad*
- *Electrical Config*
- *Wi-Fi*
- *Miscellaneous*
- *About*

To select an item, slide the right wheel until the desired icon is highlighted in the middle or press on the menu name.

Keypad functions



Water Care

The Water Care page will help you set up your ideal filtration and heating settings. Choose between *Away from Home*, *Standard*, *Energy Savings*, *Super Energy* and *Weekender*, depending on your need. Touch the Water Care name to choose your setting. A green checkmark will appear on the selected icon to confirm your choice.

When you select another water care setting, a confirmation window appears to prevent inadvertent selection that could result in a setup modification for your spa.

In Economy mode, the set point will be reduced by 20°F*, which means that the heating system will not be engaged unless the temperature falls to 20°F below the spa's set temperature.

The filtration schedule shown on the in.k1000+ screen will apply to the main filtration pump, most likely pump 1. If your spa uses a circulation pump configured to run 24 hours, the screen will show you the purge setting instead of filtration. The purges are pre-programmed for a fixed number of minutes, therefore the duration will be set to N/A on the screen and only the start time can be modified.

* Default pack value

Water care modes



Away:

In this mode the spa will always be in economy; the set point will be reduced by 20° F.



Standard:

The spa will never be in economy mode and will be filtering according to the pack's low level configuration.



Energy Savings:

The spa will be in economy mode during the peak hours of the day and resume normal mode on the weekend.



Super Energy Savings:

The spa will always be in economy mode during peak hours, every day of the week.



Weekender:

The spa will be in economy mode from Monday to Friday, and will run normally on the weekend.



Keypad functions

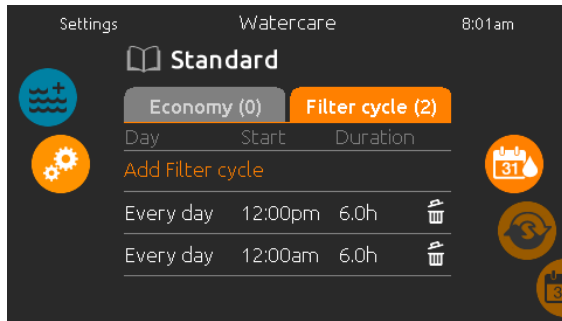

Modifying schedules

To modify a Water Care category, touch the pencil icon at the right end of the desired Water Care to open the selected Water Care menu.

Touch the Economy tab to change the economy setting and Filter cycle tab for the filtration settings (or schedules). You can add economy or filtration schedules by touching the orange line labelled « Add Filter cycle » or "Add Economy cycle".

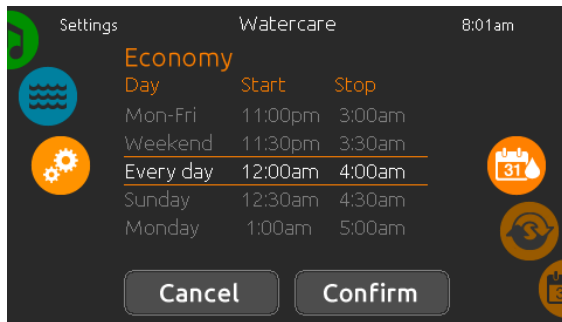

To delete a schedule, touch the garbage can icon at the right end of the desired line. Confirm your action when prompted.

You can modify the programmed schedules by selecting one and adjusting the schedule.

You have several possibilities for the schedule (Mon-Fri, weekend, every day, or single days). The schedules will be repeated every week. The time and duration are set in 30 minute increments. When changes are done, press "confirm". If you don't want to keep any changes, press "cancel" or use the calendar icon to go back. Ensure that you have selected the desired Water Care mode in the main Water Care menu.

Keypad functions

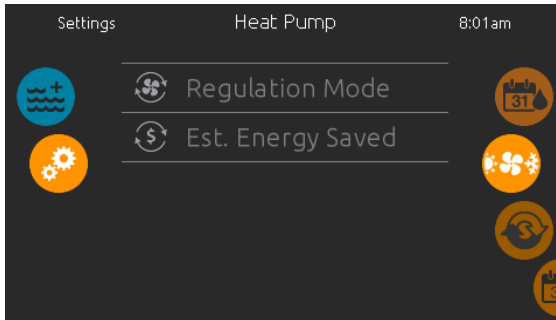

*If a Gecko Brand Heat Pump (in.temp) is connected to your spa setup, the following Menu will appear when selecting Heat Pump in the Settings Menu instead of the Regulation Mode Menu.

Heat Pump

From the Settings page, you can access the *Heat Pump* menu, which gives you access to the following Heat Pump Modes:

- *Eco Heat*
- *Smart Heat*
- *Eco Auto*
- *Smart Auto*
- *Cool*
- *Electric*

Slide to make a selection and Press on it to confirm. When you select a Heat Pump Mode, you will be asked to confirm your choice.

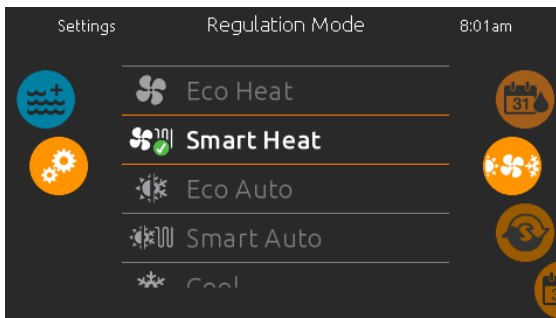

Regulation Mode

The Regulation Mode page will help you set up your ideal Heat Pump regulation settings. Choose between *Eco Heat*, *Smart Heat*, *Eco Auto*, *Smart Auto*, *Cool* and *Electric*, depending on your need. Touch the Regulation Mode name to choose your setting. A green checkmark will appear on the selected icon to confirm your choice.

When you select another Regulation Mode setting, a confirmation window appears to prevent inadvertent selection that could result in a setup modification for your spa.

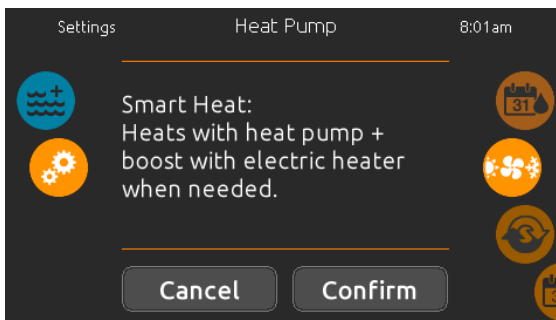



Keypad functions

Heat pump modes



Eco Heat

In this mode, the heat pump is used as the unique source of heating. The heating element is kept off and the heat pump is not used to cool the water should its temperature rise above the current set point.



Smart Heat

This mode uses the heat pump as the main heating source. The heating element is turned on only if there is a large temperature difference between the water and the set point. The heat pump is not used to cool the water in this mode.



Eco Auto

This mode borrows functionality from both Eco Heat and Cool modes and has the ability to select the proper Heat or Cool mode automatically according to the water temperature. The heating element is never activated in this mode.



Smart Auto

This mode borrows functionality from both Smart Heat and Cool modes and has the ability to select the proper Heat or Cool mode automatically according to the water temperature. The heating element is activated only if there is a large temperature difference between the water and the set point.



Cool

This mode uses the heat pump in cooling mode only. The heat pump is not used as a heating source and the heating element is never activated.



Electric

This mode keeps the heat pump off and uses only the heating element to regulate water temperature.

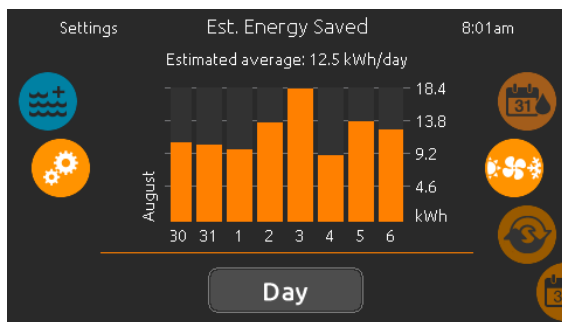

Est. Energy Saved

Only available with a Gecko Brand Heat Pump (in.temp)

In this section, you can view your estimated kWh economy graph. These calculations are made while using a in.temp to heat your spa. The economy estimate can be viewed in days or months format by pressing the button below the graph.

Disclaimer:

The data provided by this tool is estimated by sampling numerous operating parameters in real time in order to generate an estimate that is as close as possible to reality. The data is presented to the users with the best intention but Gecko Alliance inc. makes no warranty about its accuracy or completeness. To increase the accuracy of those estimates, make sure the heat pump is well maintained and operates in the recommended conditions in regards to water flow, air exchange through discharge panel, adequate compressor pressure and cleanliness of pipes and heat exchanger.

Keypad functions

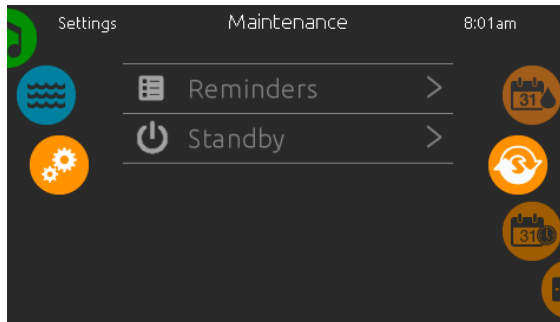

Maintenance

From the Maintenance page you can access the following:

- *Reminders*
- *Standby*

To access the desired option simply touch the corresponding menu item.

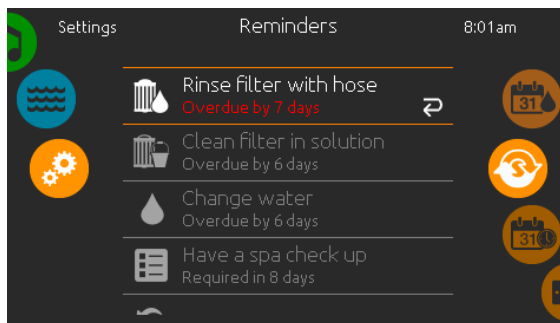

Reminders

The in.k1000+ keypad will provide reminders about maintenance required on your spa, like rinsing or cleaning the filter. Every task has its own duration based on normal use.

The Reminders menu allows you to check the time left before maintenance is required, as well as to reset the time once a task has been completed.

To reset a task, select it by pressing the curved arrow, then confirm when prompted. Once you have confirmed, the task will be reset.

You can also use the option *Reset Reminders* to reset all the reminders.

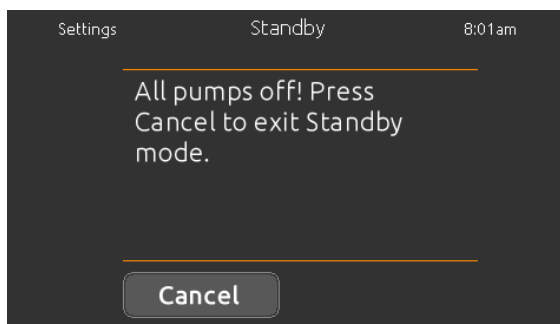

Standby

The Standby mode allows you to service your spa. Pumps will stop for 30 minutes and will automatically restart after.

The normal page will return at the end, once the pumps will be restarted.

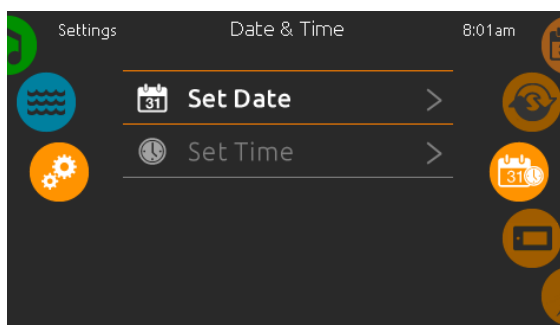

Date and Time

Use this page to change Date/Time settings.



Keypad functions



Set date

Here you can adjust the year, month and day.

Simply swipe up and down the column you want to change and select the desired value. When you are done, touch the calendar icon at the right of the screen.

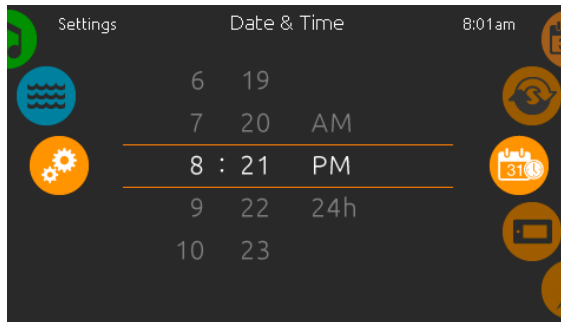

Set time

Here you can change the hour, minute and time format.

Simply swipe up and down the column you want to change and select the desired value. When done, touch the calendar icon at the right of the screen.

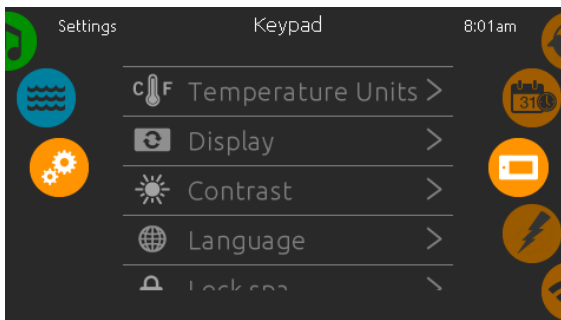

Keypad settings

In the keypads page you can access the following:

- *Temperature units*
- *Display*
- *Contrast*
- *Language*
- *Lock spa (optional)*
- *Keypad color (optional)*

To select an item, slide the right wheel until the desired icon is highlighted in the middle or press on the menu name.

Keypad functions



Temperature units

Choose the desired units to display temperatures.

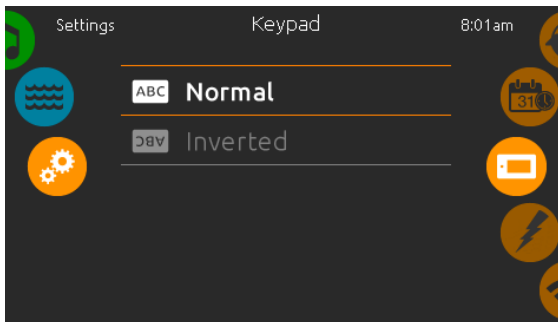

Display page

Use this page to change the display orientation.

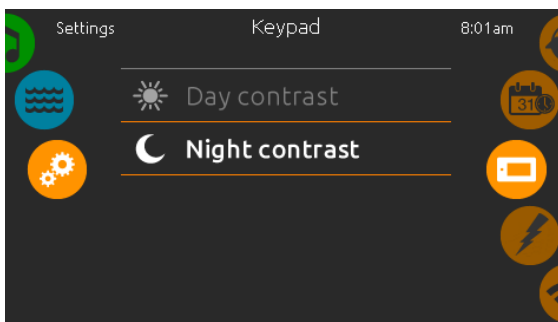

Contrast page

Use this page to change the keypad contrast.



Keypad functions

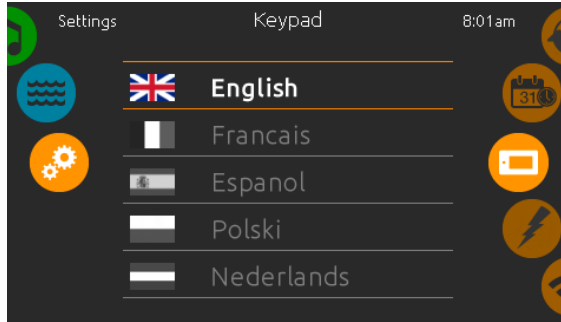

Language select

Use this page to select the display language of the in.k1000+ keypad.

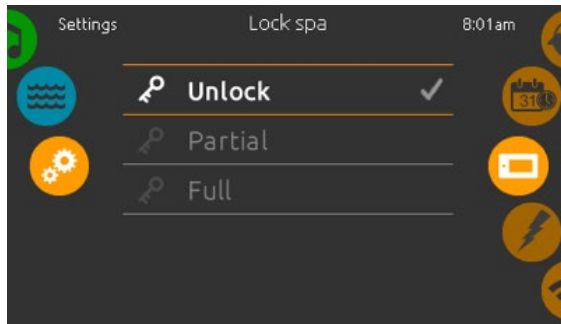

Keypad lock/unlock (optional)

When this option is enabled, the user can partially or completely lock the keypad. When the user wants to lock the keypad he is asked to select a 4-digit code. The same code will be needed to unlock the keypad. Next time he wants to lock the keypad, he will be prompted again to select a 4-digit code (same functionality as a Safe in a hotel room).

The keypad can be unlocked with a universal unlock code (3732) or by a reset of the keypad.

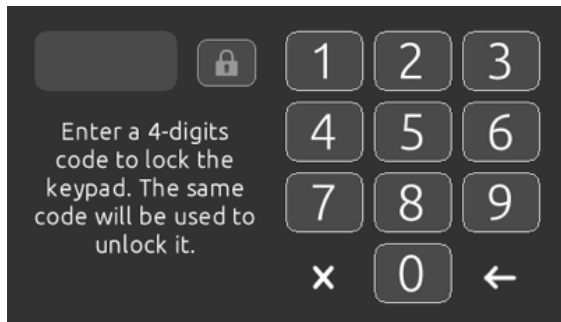

When Full Lock is selected, all functions are locked.

In Partial Lock, you may only activate accessories. Settings may not be changed in this mode.

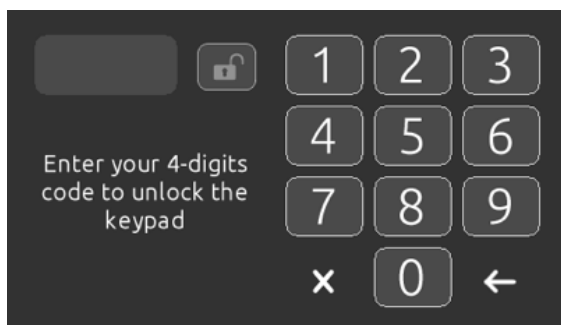

Keypad functions

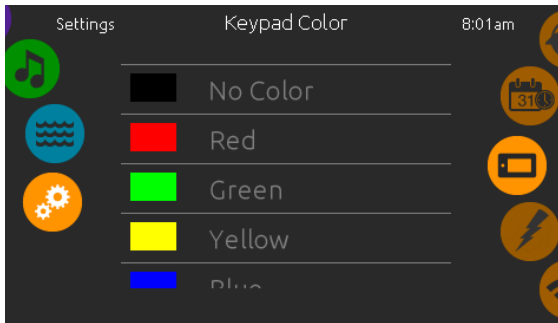

Keypad Color (optional)

If this option is available (depending on the spa configuration), the keypad rim color can be changed. 8 pre-defined colors are available. If the in.mix is installed, the keypad rim color can also be associated to an in.mix zone.

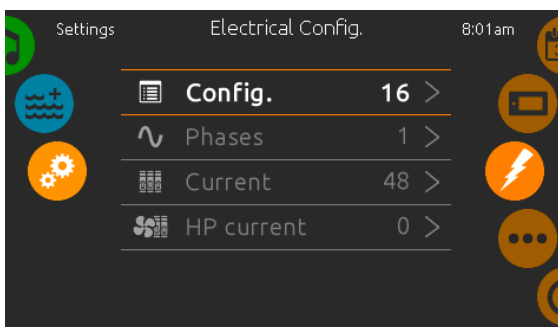

Electrical Configuration

Please do not make any changes in this section unless you are a qualified electrician.

In this section, you can change the low-level configuration, modify the number of phases, change the input current value as well as change the Heat Pump current. Once the modification is done, hold the Apply button for five seconds.

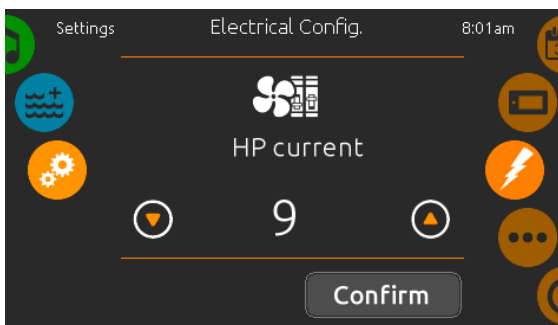

Please note that if there are two spa packs in the system (i.e. a SwimSpa installation), the master's unit's chosen unit configuration must support a slave unit. If after rebooting the chosen configuration does not support SwimSpa installations, the in.k1000+ will return (after approximately 45 seconds) to this configuration menu and prompt the user to select a configuration number again.

* Depending on the pack configuration, a code may be required to modify these settings. This code is 5555.

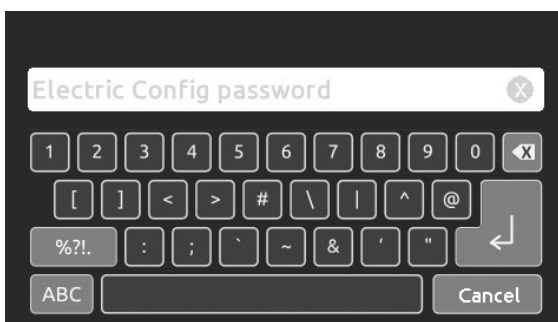
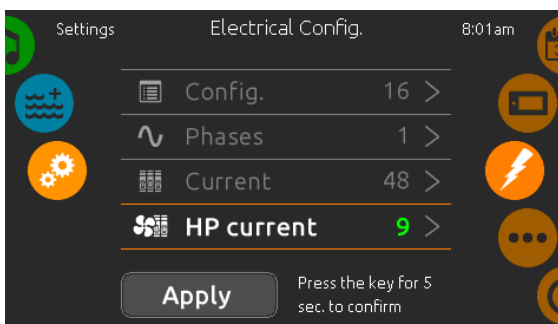



Keypad functions

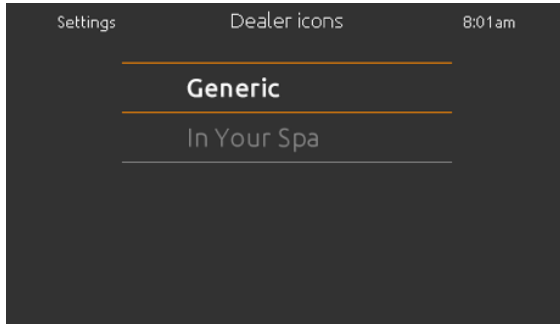

Select logo

After confirmation, the keypad will reset to reconfigure the system. You will be asked to select the custom icons used in the sleep mode.

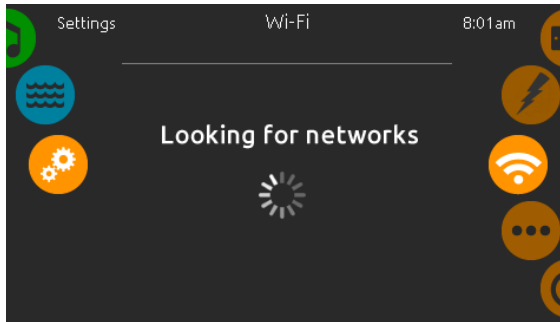

Wi-Fi (in.touch only)

This page allows you to connect your in.touch module to a Wi-Fi network or to change its network.

For more details about other in.touch connection methods, please see the in.touch techbook.

After a few seconds the available networks will appear on the screen, as well as their signal strength.

Swipe Up or Down the list to select your network.

If the Wi-Fi network is password protected, enter it when prompted.



If no password is required, the in.touch will connect automatically.

Once the in.touch module is connected to a Wi-Fi network, a green check mark will appear in the Wi-Fi menu and the network name will appear in the *Settings* menu.

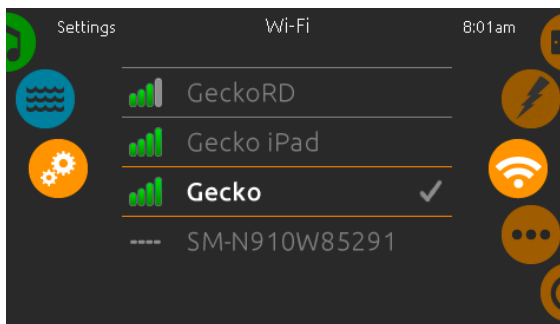

Keypad functions

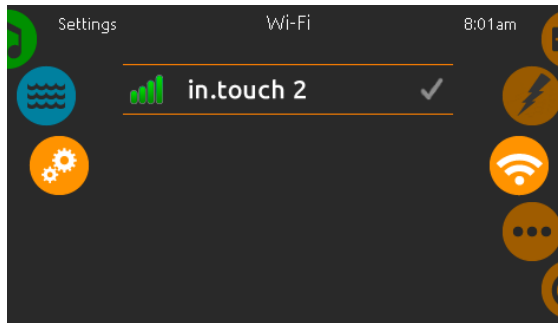

Wi-Fi (in.touch 2)

When a in.touch 2 is detected, this network will appear (in.k1000+ version 12 and older).

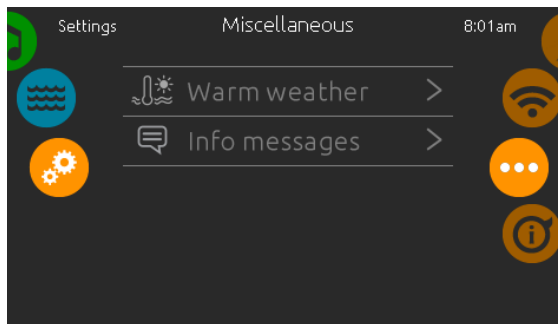

Miscellaneous

This menu gives access to modify the Warm Weather option and info messages in the media center.

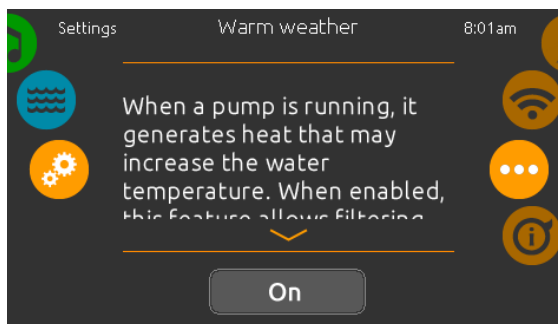

Warm weather

When pumps are running, they produce heat that may increase your water temperature. "Warm Weather" option gives you the option to bypass the pack filtration over-temperature feature. When Warm Weather is "OFF" the filtration over-temperature is disabled and your spa filtering will continue even if the water temperature is high.



Keypad functions

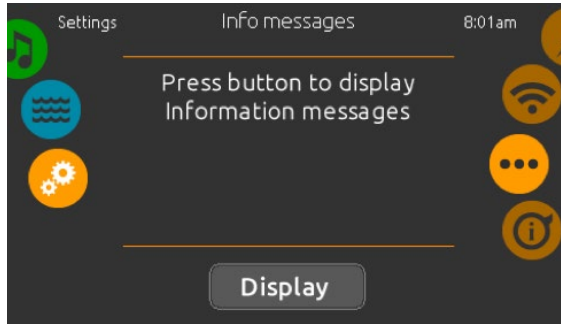

Info messages

Press display/hide key to modify message display: If hide option is selected, smart winter mode message will only appear when a SWM purge is in action. Otherwise the message will always appear when the spa is in a SWM condition. If hide option is selected, heating suspended and filtering suspended messages will not appear.

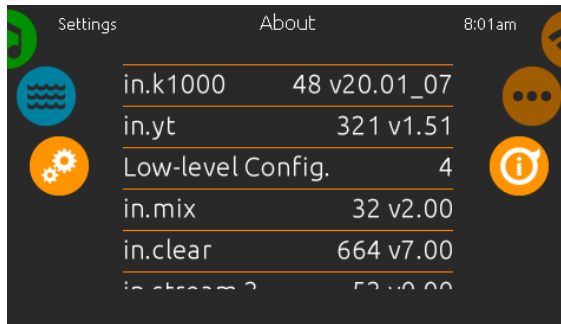

About

This section shows information about the in.k1000+ software number and the revision numbers of the different components of your system.

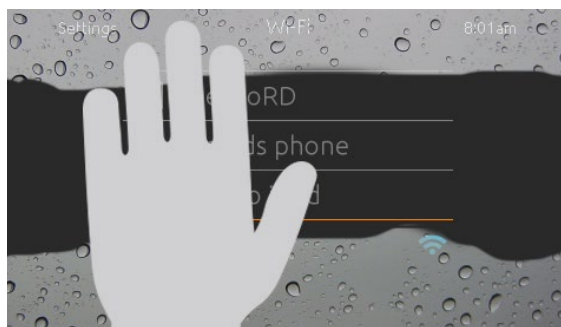

Wipe screen

This message appears when too much water is detected on the touch screen. Simply wipe away excess water.

Keypad functions

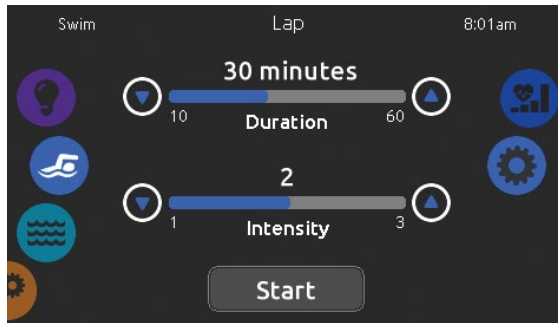

Swim functions

This menu is available only if the Swim option is activated in the spa configuration.

The *Duration* of all training drills and the *Intensity* of all pre-set training drills are set in this page. The number of available intensities depends on the swim spa configuration and on the selected training drill, whose name is displayed at the top of the screen. The intensity of personalized drills is set during the drill creation and can be edited from the Training Drills selection page.

From this page, you can also access the following:

- *Training Drills selection*
- *Swim Settings*

To select an item, slide the right wheel until the desired icon is highlighted in the middle.

When ready, press *Start* to begin the workout session. *Resume* and *Stop* buttons are also available when a swim session was previously paused.



Swim settings

In the *Swim settings* page, you can access the following parameters:

- *Warm up*
- *Cooldown*
- *Step Time*
- *Preparation Time*
- *Light (requires an in.mix installed)*

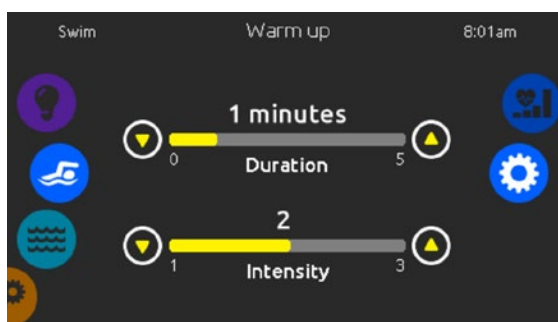

Warm up & Cooldown

These pages allow you to adjust the duration and intensity of the warm up and cooldown portion of your training drill. If no *Warm up* or *Cooldown* sessions are desired, set their respective duration to 0 minute.

Note that Warm up and Cooldown settings apply to all training drills.



Keypad functions

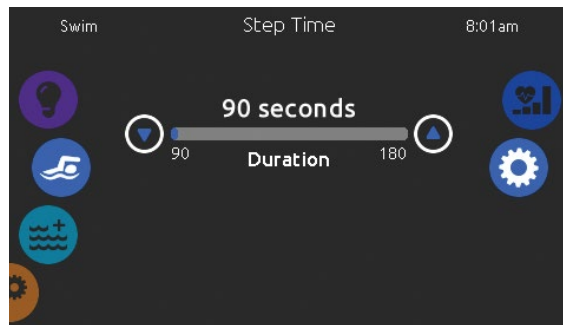

Step time

This page allows you to adjust the workout session step time. Step time applies to all training drills except *Endurance*, *Power* and *Personalized*.

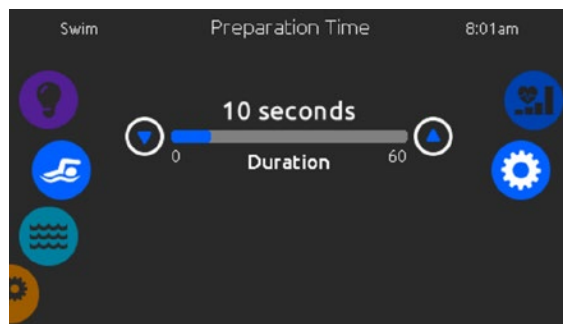

Preparation time

This page allows you to adjust the Preparation time. The preparation allows the swimmer to take place between the time when he presses on the “Start” button of the Swim page and the time when the swimming workout starts. If no *Preparation Time* is desired, set *Duration* to 0 second.

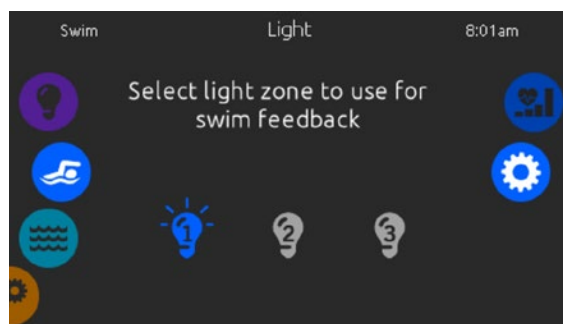

Light (requires an in.mix installed)

This page allows you to select which in.mix zone to use for swim feedback.

If at least one zone is selected for feedback, it will blink and change color depending on the progression during the swim workout:

- 1- Blinks in blue during the preparation countdown
- 2- Changes to yellow during the warm up session
- 3- After the warm up, color tones range from light blue to bright red depending on swim intensity
- 4- Blinks twice when the intensity changes during the workout
- 5- Changes to a light blue color during the cooldown session

Keypad functions

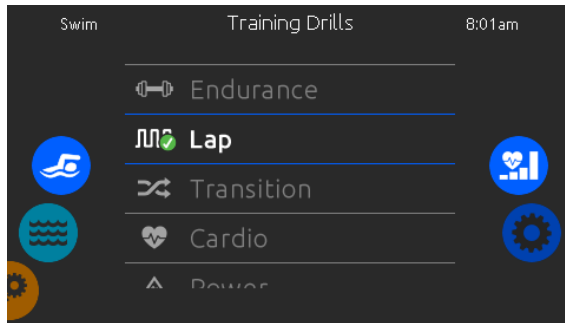

Training Drills

The Training Drills selection page allows you to choose the desired workout drill. The currently selected drill is highlighted and has a green checkmark. To select another drill, simply scroll through the list and click on its name.

**Endurance:**

In this training drill, the swimming workout will be executed at a constant intensity for the entire duration.

**Lap:**

This training drill will perform high and low intensity intervals of equal step time.

**Transition:**

This training drill will perform a series of equal steps at random intensities.

**Cardio:**

This training drill will perform two successive steps at high intensity for one step at low intensity.

**Power:**

This training drill will perform a “pyramid” program where the intensity will progressively increase until the maximum is reached. It will then decrease progressively to end at low intensity.

**Personalized:**

Three personalized training drills are available and can be edited to create a custom workout pattern. To edit a personalized training drill, touch the pencil icon at the right end of the desired personalized drill to open the training drill edit window.



Keypad functions

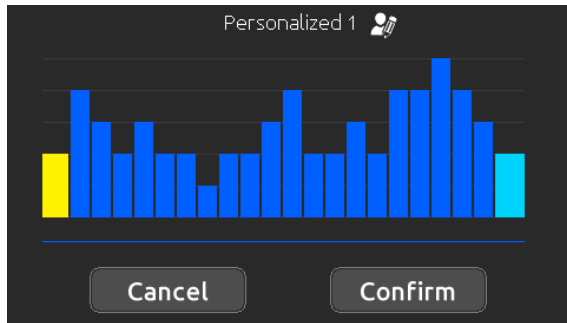

Personalized workout edits

This page allows you to create a personalized training drill. Simply draw the desired workout pattern on the screen and/or adjust each individual step to the desired intensity. The duration of the 20 available steps will be adjusted to fit the duration selected on the main screen.

When the personalized pattern is completed, press *Confirm* to save your changes and return to the swim window.

You can also press *Cancel* at any time to exit without saving your modifications.



Personalized training drills can also be renamed by clicking the pencil icon located to the right of the workout name.

Keypad functions

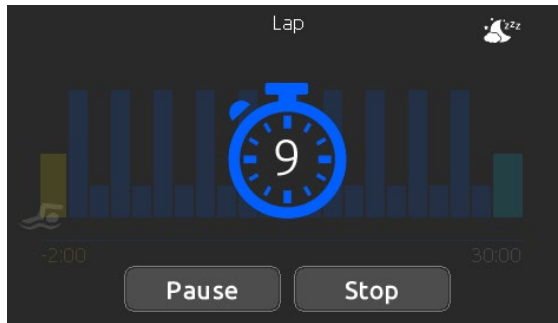

Swim workout

When you press the *Start* button, the preparation counter appears and starts to decrement, allowing the swimmer to get in position before the swimming session starts. From there, you can press *Pause* to suspend or *Stop* to interrupt the swim session and return to the main swim page.

The keypad can also be put in sleep mode by pressing the sleep icon located at the top right of the screen in order to prevent water from splashing on the keypad and inadvertently stopping the swim session.

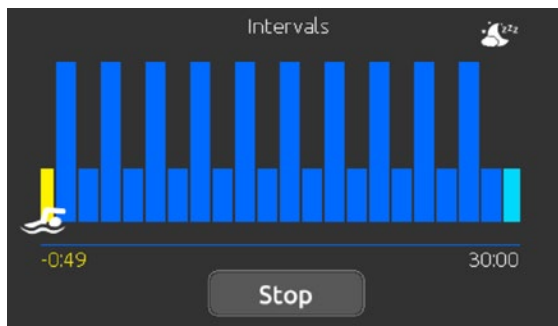

During the workout session, a summary of the session is shown.

A swimmer icon is also displayed on the screen and will move toward the right as the swim session progresses.

A yellow countdown decreases during the warm up portion of the swim session while the set workout time is displayed on the right.

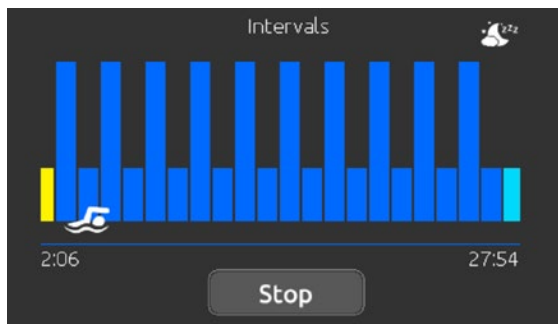

Once the warm up timer reaches zero, the workout session begins and will follow the selected training drill, shown on screen. The workout timer on the right will start to decrease as the elapsed workout time, displayed to the left of the screen, increases.

When the workout program is completed, the swimmer enters the cooldown portion of the session, displayed in light blue.

The elapsed workout time remains on the left and a light blue timer starts incrementing on the right, indicating the time spent in cooldown.

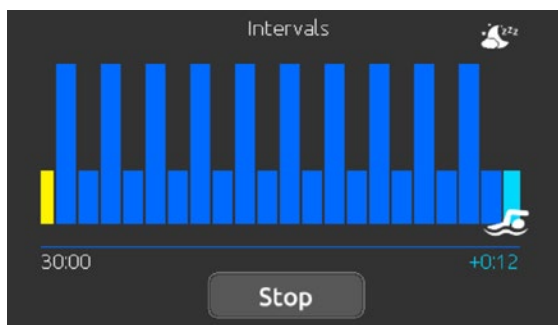



Keypad functions



in.stream 2 functions

This menu is available only if the in.stream 2 audio station is detected in the spa accessories.

The audio page will allow you to control the active audio source. Note that only the functions that apply to the selected source will be available. From this page, you can also access the following:

- *in.stream 2 on/off*
- *speaker settings*
- *audio source selection*
- *disconnect bluetooth*

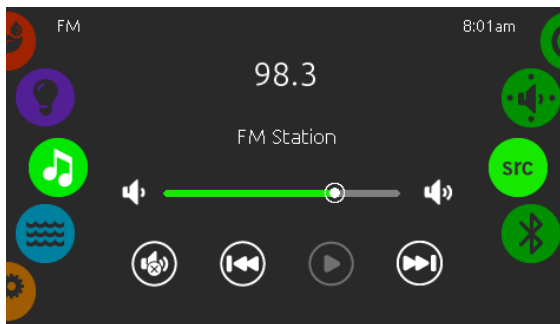

To select an item, slide the right wheel until the desired icon is highlighted in the middle.

For more information about the in.stream 2 audio station, please refer to the in.stream 2 techbook.

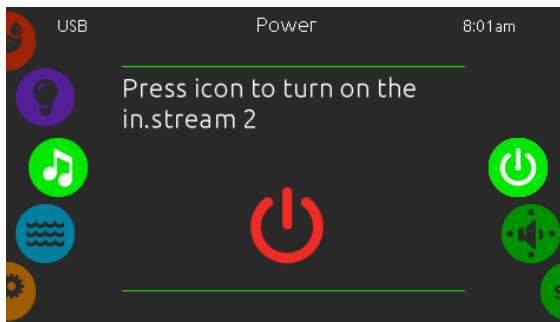

in.stream 2 power

To turn the in.stream 2 on or off, tap the icon located in the center of the screen.



On (red)



Off (green)

Keypad functions

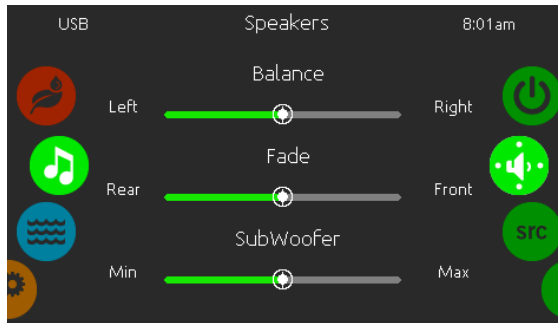

Speakers settings

Move the sliders to adjust the Balance, Fader and Subwoofer settings.

The Fader and Subwoofer sliders will only appear in the Speakers menu if the corresponding speakers are available on the in.stream 2.

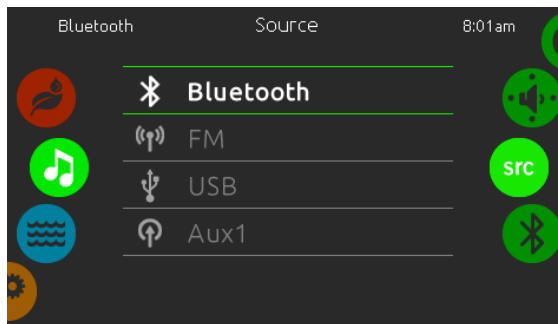

Source menu

To change the audio source, simply tap on the desired one.

Note that only the sources available on the in.stream 2 will be displayed in the source menu.

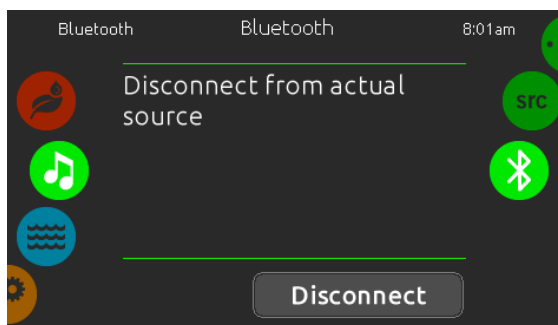

Disconnect Bluetooth

If a device with Bluetooth technology is connected to the in.stream 2, you can disconnect it by pressing the Disconnect button at the bottom of the screen.

Doing so will also prevent the in.stream 2 from automatically reconnecting to this specific device until it has been reconnected using the device itself.



Keypad functions

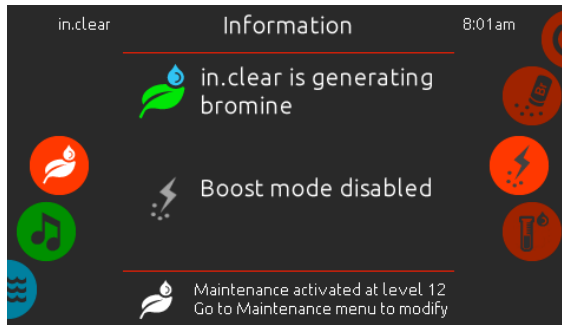

in.clear functions

This menu is available only if the in.clear is detected in the spa accessories.

The in.k1000+ keypad can be used with the in.clear sanitation system.

The *in.clear* menu allows you to configure your maintenance settings and boost levels. The main *in.clear* menu shows the current status of the sanitation system, whether it is on and if it is generating bromine or not.

For more information about the in.clear, bromine levels and other settings, please refer to the in.clear user manual.

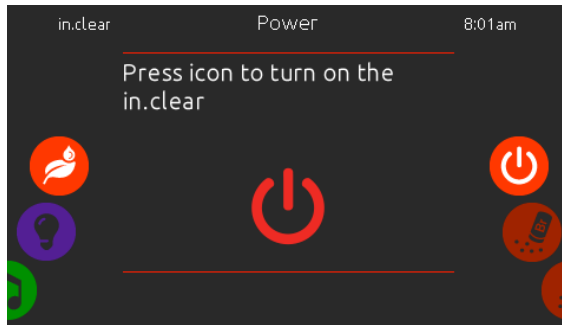

in.clear on/off

A 5 second press on the power down key is required to turn off the in.clear. This prevents accidental deactivation of the sanitation system.

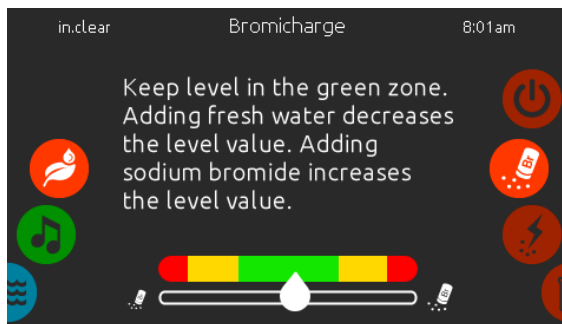

Bromicharge™ level

The Bromicharge page allows you to see the current level of sodium bromide in the water. Ideally, you should aim to be near the center of the green area of the gauge. Follow the instructions given on the screen to increase or reduce the level.

Note that it may take a few seconds to obtain a reading from the in.clear, during this time the wait icon is displayed on the gauge.

There are no settings to change on this page, it is solely informative.

Keypad functions

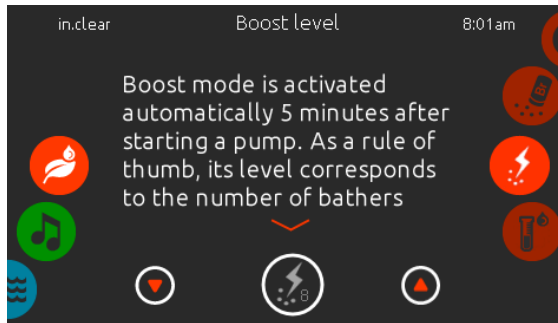

Modify the Boost level

The Boost level is used to set the amount of boost required. As a rule, enter the number of bathers in the bath. Boost mode is automatically activated 5 minutes after starting a pump.

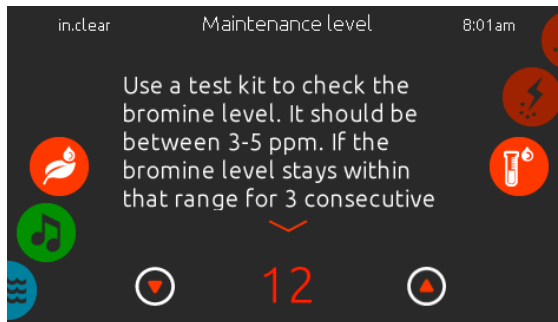

Modify the maintenance level

The maintenance level can be changed and must be tested with a bromine level tester. The tester should report between 3-5 ppm. If the bromine level is within this range for 3 consecutive days your maintenance level is correctly adjusted. If you adjust the maintenance level by more than 2, you will be prompted to confirm.



Keypad functions

in.mix functions

This menu is available only if in.mix is detected in the spa accessories.
By default, in.mix selects Zone 2 when you access the menu.



Zone selection

To select a zone, turn the right wheel until the desired icon is highlighted in the middle. This selection allows you to modify its color.

Synchronizing zones

The synchronization/desynchronization icon allows you to match the color of the selected zone with the other zones.

Changing colors

Once a zone has been selected, use the color wheel to choose the desired color, or the rainbow icon to get changing colors.

Intensity

Located at the bottom of the screen, the slider allows you to modify the intensity of the color.

On/Off

There are two ways to turn the in.mix on or off. The first one is by using the Light icon on the spa Screen. The second way is by touching the light bulb icons located on each side of the intensity bar.



Error messages

The list below shows the different error messages that can appear on the home screen.

Refer to the troubleshooting and error codes section of the TechBook for your spa pack system.

Please note that if you are in a swim spa configuration, the message may be followed by "Master" or "Slave" to designate from which pack the error is coming.

Code	Message
HL	High Limit circuit has tripped!
FLO - L01 FLO - L02 FLO	FLO condition - Check filter, pump, blockage, air lock and water level
NO FLO	Persistent NO FLO, all off - Check filter, pump, blockage, air lock and water level
HR	A hardware error was detected (Relay stuck)
OH	Spa temperature is too high
Pr	Temp probes or detection circuit are defective
AOH	Elevated internal temperature
FLC	The pressure switch is closed
SP in	Input voltage issue
RH NC	Comm. error between in.xm2 - in.therm
RH ID	in.xm2 and in.therm incompatible
SC ER	Error detected during the learning mode
F1	in.xm2 Fuse # 1 is blown
F2	in.xm2 Fuse # 2 is blown
F3	in.xm2 Fuse # 3 is blown
ER1	SwimSpa config. : slave unit is missing
Hr	Hardware error was detected (Thermal fuse)
UPL	The spa pack does not have valid software. Please insert valid in.stick to reprogram spa pack.
CFLO	No Flow condition
HiBr	Add fresh water to the spa
HiBr	Add fresh water to the spa
LoBr	Add BromiCharge to spa water
NoBr	Add BromiCharge to spa water
Comm	Verify cable connections
Supp	Connect power cord to 240 V source
HP1-99	Heat Pump error! Service Code 1-99, Contact Dealer



Feature matrix

The following table presents the features and/or options available for the in.k1000+ keypad and the earliest software version at which this feature/option is available. All later versions greater than the earliest version continue to support the feature.

Also note that the in.k1000+ includes all features and/or options that were available on the in.k1000.

Keypad functions	Earliest support
Swim functions	5.00
Heat pump functions	14.00



Specifications

Model	Part number	Description
in.k1000+	0607-005033	IN.K1000-V2-BK-GE1
in.k1000+ 25' cable	0607-005036	IN.K1000-V2-BK-25FT-GE3
in.k1000+ chinese	0607-005035	IN.K1000-V2-BK-CHINESE-GE1
in.k1001+	0607-008087	IN.K1001-V2-CL-GE1
in.k1001+ 25' cable	0607-008088	IN.K1001-V2-CL-25FT-GE2

Environmental

Operating temperature:	-4°F (-20°C) to 149°F (65°C)
Storage temperature:	-22°F (-30°C) to 185°F (85°C)
Water ingress protection:	IPX5

Mechanical

Weight:	1.05 lbs (0.48 kg)
Dimensions (W x H x D):	7,49" x 5,17" x 1,93" (190 mm x 1031 mm x 49 mm)

Audio specifications

Audio source supported:	in.stream 2
--------------------------------	-------------

Compatibility

in.yt, in.ye, in.yj, in.xe, or in.xm2 spa packs with appropriate software revision



9919-101605-C
Rev. 12-2019

© Groupe Gecko Alliance inc., 2019
All trademarks or registered trademarks
are the property of their respective owners.

Gecko Alliance
450 des Canetons, Québec (Qc), G2E 5W6 Canada, 1.800.78.GECKO
www.geckoalliance.com

Printed in Canada